

Content

1 General informations for disassembling the modulate action valve with diaphragm 2

2 Purpose 2

3 Competence 2

4 Scope 2

5 Disclaimer..... 2

6 Qualified fitting personnel..... 2

7 Remarks..... 2

8 Basic safety guidelines 3

9 Assembly instructions..... 6

protected

disclosure cat.:	II	proofread:	Cal	published date:	tbd	effect. date:	02/12
author:	AW	released by:	KUW	replaces:	initial	status:	published
resp. depart.:	PP	date of release:	01/31/12	revision No.:	0		
doc. type:	LGS	change rep. No.:		retention period:	10y.		

1 General informations for disassembling the modulate action valve with diaphragm

2 Purpose

The documentation describes the disassembly of the modulate action pilot valve with diaphragm. The description contains every single working step, supplies, tools and appliances.

3 Competence

The generation, maintenance and distribution of the documentation takes place in the organisation department. The defaults will be generated by the technical department in consultation with the final assembly department and production planning department.

4 Scope

This document must be applied to the dismantling of a Pilot Operated Safety Valve in agencies and subsidiaries of LESER GmbH & Co. KG, customers and independent service center.

5 Disclaimer

LESER puts in a great deal of effort into making up-to-date and correct documentation available. Nevertheless, LESER GmbH & Co. KG gives no guarantee that the recommended actions presented here are entirely correct and error free. This document is to be applied exclusively to the specified type. LESER GmbH & Co. KG declines any liability or responsibility for the correctness and completeness of the content.

LESER GmbH & Co. KG reserves the right to change the information contained in this document, which is for the products of LESER GmbH & Co. KG and is intended for LESER subsidiaries, at any time and without prior announcement.

LESER GmbH & Co. KG is available to the users of this document to provide additional information.

6 Qualified fitting personnel

LESER safety valves may only be dismantled by trained or qualified fitters. The qualifications must be obtained through the appropriate training measures.

7 Remarks



Gloves must be worn during the entire dismantling process.

protected

disclosure cat.:	II	proofread:	Cal	published date:	tbd	effect. date:	02/12
author:	AW	released by:	KUW	replaces:	initial	status:	published
resp. depart.:	PP	date of release:	01/31/12	revision No.:	0		
doc. type:	LGS	change rep. No.:		retention period:	10y.		

8 Basic safety guidelines

Dangerous media

Poisoning, caustic burns, burns, injuries

- Use suitable protective devices
- Use suitable collecting tanks.
- Wear suitable protective equipment.

Foreign bodies in the safety valve

Danger from failure of safety valve or leaks

- Flush the system before installation of a safety valve.
- Check the safety valve for foreign objects.
- Remove foreign objects

Bug screen is damaged or missing (B or option)

Dirt, objects or insects get into the safety valve. Danger from malfunction of the safety valve.

- Install the bug screen correctly.
- Check the bug screen regularly.

Ambient temperature is too high

Material expansion. Danger from malfunction of the safety valve.

Ambient temperature is too low

Icing, freezing vapours, reduced flow rate due to congealing media. Danger from functional disruption of the safety valve.

Abrasive or corrosive media

Moving parts jam or become stuck. Danger from functional disruption of the safety valve.

- Service the safety valve after each time it opens.

Media with high proportion of particles (only B)

disclosure cat.:	II	proofread:	Cal	published date:	tbd	effect. date:	02/12
author:	AW	released by:	KUW	replaces:	initial	status:	published
resp. depart.:	PP	date of release:	01/31/12	revision No.:	0		
doc. type:	LGS	change rep. No.:		retention period:	10y.		

protected

Deposits and clogging. Danger from malfunction of the safety valve.

- Use a filter with the correct mesh size.
- Use additional filters to increase the filter capacity.

Residual media in the safety valve

Poisoning, caustic burns, burns, injuries

- Wear suitable protective equipment.
- Remove residual media

WARNING

Leaky safety valve

Danger from leaking media due to damaged gaskets and sealing surfaces.

- Protect the safety valve against vibrations and blows especially during transport and installation.
- Check safety valve regularly for leaks.

Open bonnet or spindle guides

Danger from leaking media

- Make sure that no danger can arise from leaking media.
- Keep a safe distance.
- Wear suitable protective equipment.

CAUTION

Hot medium

Burns or scalding.

- Wear suitable protective equipment.

Hot surfaces

Burns.

- Wear suitable protective equipment.

Aggressive medium

Caustic burns.

- Wear suitable protective equipment.

Open bonnet or spindle guides

protected

disclosure cat.:	II	proofread:	Cal	published date:	tbd	effect. date:	02/12
author:	AW	released by:	KUW	replaces:	initial	status:	published
resp. depart.:	PP	date of release:	01/31/12	revision No.:	0		
doc. type:	LGS	change rep. No.:		retention period:	10y.		

Pinching danger from moving parts.

- Install suitable safeguards.

Sharp edges and burrs

Danger of injury.

- Wear safety gloves.
- Handle the safety valve carefully

High noise emission

Hearing damage.

Wear ear protection.

protected

disclosure cat.:	II	proofread:	Cal	published date:	tbd	effect. date:	02/12
author:	AW	released by:	KUW	replaces:	initial	status:	published
resp. depart.:	PP	date of release:	01/31/12	revision No.:	0		
doc. type:	LGS	change rep. No.:		retention period:	10y.		

9 Assembly instructions

9.1 Assembly of the manifold block

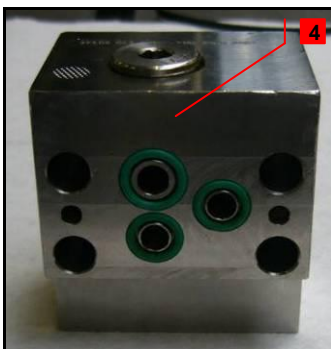
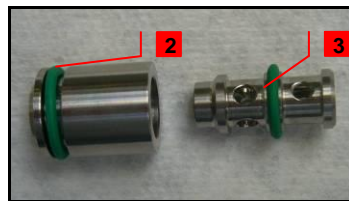
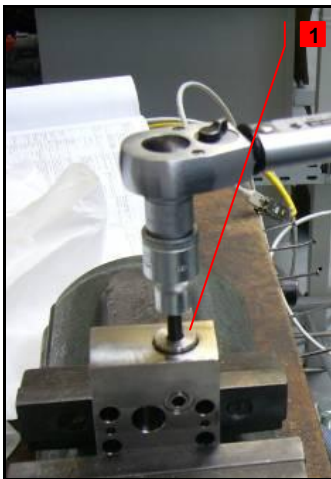
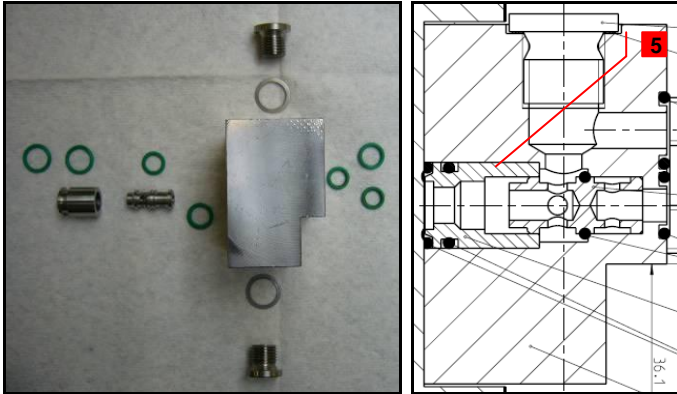

1. Steps – Descriptions

- 1** Screw lock screw [24.7] with gasket [24.8] into manifold block [24.1]
 - 2** Complete bushing [24.2] with O-ring [24.5] (O-ring is 10,82 x 1,78)
 - 3** Complete piston [24.3] with O-ring [24.4] (O-ring is 7,65 x 1,78)
- !** Without soapy water!
- 4** Complete manifold block [24.1] with piston [24.3], bushing [24.2] and O-rings
2 x 7,65 x 1,78 ;
2 x 9,25 x 1,78 ;
1 x 10,82 x 1,78
 - 5** Consider the correct alignment of piston

Check the ease of movement of piston by rotating manifold block

2. Supplies

Soapy water [24.5]
Lubricate components acc. to LID

3. Tools

Allen key acc. to LID
Hook tool for O-rings
Tightening torques acc. to LID

4. Appliance

Parallel vice with aluminium jaws
Test bench

protected

disclosure cat.:	II	proofread:	Cal	published date:	tbd	effect. date:	02/12
author:	AW	released by:	KUW	replaces:	initial	status:	published
resp. depart.:	PP	date of release:	01/31/12	revision No.:	0		
doc. type:	LGS	change rep. No.:		retention period:	10y.		

9.2 Assembly of the feeding seat unit



1. Steps – Descriptions

1 Screw (lower) disc exhaust [11] together with (lower) disc exhaust extension [45]

Cover O-ring (30 below + 34) with soapy water

2 Pull O-rings (30 below, 31, 34) on disc exhaust (lower) [11]

Caution: Do not mix up O-ring (31) with PTFE-coating with O-rings (30 lower)!

Make sure that O-rings are twist free

3 Stick (lower) disc, feeding [8] and seat feeding [5] on (lower) disc exhaust [11], put O-ring [30 upper] on (lower) disc, feeding [8] screw together with (upper) disc feeding [7]

Make sure that O-rings are twist free

2. Supplies

Soapy water

Lubricate components acc. to LID

3. Tools

Helpful: O-ring-mounting aid (30+34)

Hook tool for O-rings

Drift pin

Open-end wrench acc. to LID

Torque wrench (Tightening torques acc. to LID)

4. Appliance

None

protected

disclosure cat.:	II	proofread:	Cal	published date:	tbd	effect. date:	02/12
author:	AW	released by:	KUW	replaces:	initial	status:	published
resp. depart.:	PP	date of release:	01/31/12	revision No.:	0		
doc. type:	LGS	change rep. No.:		retention period:	10y.		

9.3 Assembly of the O-ring 32 + 46

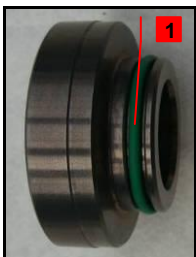
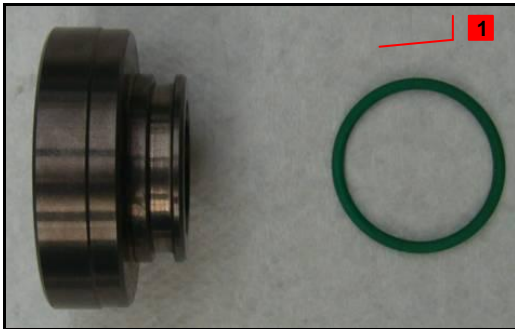

1. Steps – Descriptions

1 Cover O-ring [46] (O-ring is 21,95 x 1,78) with soapy water and pull O-ring on guide bush [2]

2 Cover O-ring [32] (O-ring is 12,37 x 2,62) with soapy water and pull O-ring on piston [41]

Make sure that O-rings are twist free

protected

2. Supplies

Soapy water
Lubricate components acc. to LID

3. Tools

Helpful: O-ring mounting aid [32]
Hook tool for O-rings

4. Appliance

None

disclosure cat.:	II	proofread:	Cal	published date:	tbd	effect. date:	02/12
author:	AW	released by:	KUW	replaces:	initial	status:	published
resp. depart.:	PP	date of release:	01/31/12	revision No.:	0		
doc. type:	LGS	change rep. No.:		retention period:	10y.		

9.4 Assembly of the piston and seat unit

1. Steps – Descriptions



Remove protection cap of piston [41] – if necessary

Place disc/seat unit –out of 9.2- in parallel vice with aluminium jaws

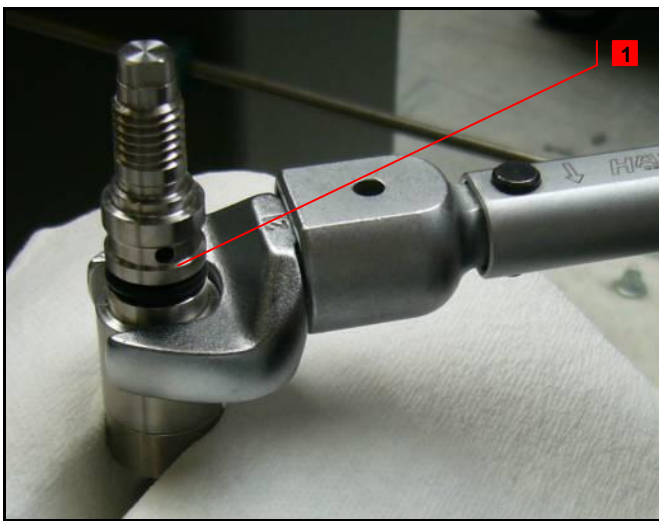

1 Screw piston [41] on disc/seat unit - out of 9.2

2. Supplies

Lubricate components acc. to LID

3. Tools

Open-end wrench acc. to LID
Torque wrench (Tightening torques acc. to LID)



4. Appliance

Parallel vice with aluminium jaws
Assembling aid

protected

disclosure cat.:	II	proofread:	Cal	published date:	tbd	effect. date:	02/12
author:	AW	released by:	KUW	replaces:	initial	status:	published
resp. depart.:	PP	date of release:	01/31/12	revision No.:	0		
doc. type:	LGS	change rep. No.:		retention period:	10y.		

9.5 Assembly of the piston and guide bush

1. Steps – Descriptions



1 Cover O-ring [32] with soapy water and pull guide bush [2] on piston [41]

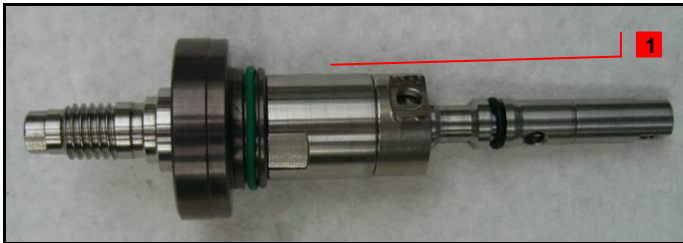

Test ease of movement

protected

2. Supplies

Soapy water
Lubricate components acc. to LID

3. Tools

None

4. Appliance

None

disclosure cat.:	II	proofread:	Cal	published date:	tbd	effect. date:	02/12
author:	AW	released by:	KUW	replaces:	initial	status:	published
resp. depart.:	PP	date of release:	01/31/12	revision No.:	0		
doc. type:	LGS	change rep. No.:		retention period:	10y.		

9.6 Insert disc and piston unit into the body



1. Steps – Descriptions

Blow out dust before assembly

1 Cover O-Ring [31+46] with soapy water

2 Insert disc, piston, guide unit carefully and completely into body [1]

protected

2. Supplies

Soapy water
Lubricate components acc. to LID

3. Tools

Brush

4. Appliance

Test bench

disclosure cat.:	II	proofread:	Cal	published date:	tbd	effect. date:	02/12
author:	AW	released by:	KUW	replaces:	initial	status:	published
resp. depart.:	PP	date of release:	01/31/12	revision No.:	0		
doc. type:	LGS	change rep. No.:		retention period:	10y.		

9.7 Assembly of the spacer and body

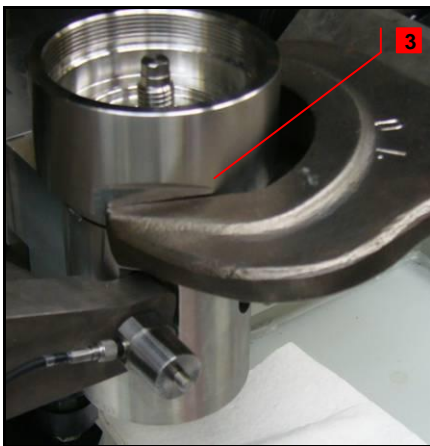

1. Steps – Descriptions

- 1** Put O-ring [74] into groove of body [1]
- 2** Lubricate thread of body [1] (M56x1,5)
- 3** Screw on spacer [75]
- 4** Tightening lock screw (hexagon screw) [77]

protected

2. Supplies

Molykote D Paste
Lubricate components acc. to LID

3. ,Tools

Ring wrench acc. to LID
Torque wrench (Tightening torques acc. to LID)

4. Appliance

Test bench

disclosure cat.:	II	proofread:	Cal	published date:	tbd	effect. date:	02/12
author:	AW	released by:	KUW	replaces:	initial	status:	published
resp. depart.:	PP	date of release:	01/31/12	revision No.:	0		
doc. type:	LGS	change rep. No.:		retention period:	10y.		

9.8 Assembly of the diaphragm

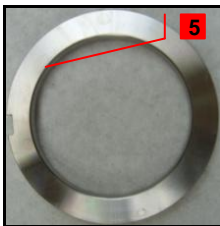
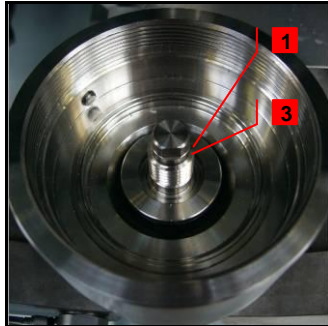

1. Steps – Descriptions

- 1 Push diaphragm retainer [78] on piston [41]
- 2 Cover O-ring [73] (O-ring is 10,77x2,62 9) with soapy water
- 3 Put O-ring (73) into groove
Optional: Check FEP-protection foil (79) for any damage
Optional: put in FEP-protection foil
Check diaphragm for any damage
- 4 Insert diaphragm [72] with labelling to bottom
- 5 Insert ring [76]
(hexagon screw for positioning)
- 6 Push diaphragm washer [71] on piston
- 7 Lubricate thread of piston [41]
- 8 Screw nut [70] until 1 mm against stop by hand
- 9 Tightening nut with wrench and counter piston with a second wrench

2. Supplies

Soapy water
Molykote D paste
Lubricate components acc. to LID

3. Tools

Ring wrench acc. to LID
Open-end wrench acc. to LID
Torque wrench (Tightening torques acc. to LID)

4. Appliance

Test bench

protected

disclosure cat.:	II	proofread:	Cal	published date:	tbd	effect. date:	02/12
author:	AW	released by:	KUW	replaces:	initial	status:	published
resp. depart.:	PP	date of release:	01/31/12	revision No.:	0		
doc. type:	LGS	change rep. No.:		retention period:	10y.		

9.9 Closing the body's bottom side

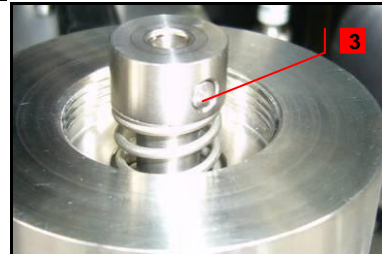
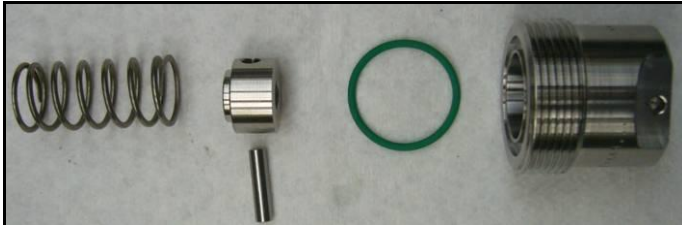

1. Steps – Descriptions

Spin body [1] by 180°

1 Insert return spring [42] into body [1]

2 Put coupling [43] on lower end of spring,

3 Span return spring [42] with coupling [43] and save coupling [43] by sticking parallel pin [44] into hole

4 Put O-ring [35] (O-ring is 21,95x1,78) into groove of plug [20]

5 Lubricate thread of plug [20]

6 Screw plug [20] and body [1] together

2. Supplies

Molykote D Paste
Lubricate components acc. to LID

3. Tools

Open-end wrench acc. to LID
Torque wrench (Tightening torques acc. to LID)

4. Appliance

Test bench

protected

disclosure cat.:	II	proofread:	Cal	published date:	tbd	effect. date:	02/12
author:	AW	released by:	KUW	replaces:	initial	status:	published
resp. depart.:	PP	date of release:	01/31/12	revision No.:	0		
doc. type:	LGS	change rep. No.:		retention period:	10y.		

9.10 Assembly of the bonnet

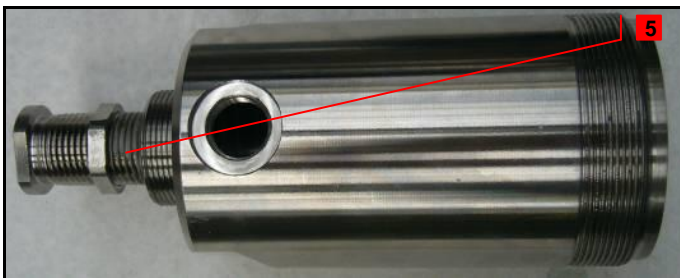
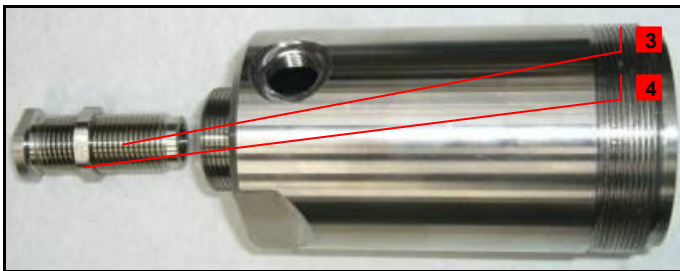

1. Steps – Descriptions

Spin body [1] by 180°

1 Place (upper) piston [47] on piston [41]

Check free movement of (upper) piston [47] to avoid a clamp

2 Put guide ring [80] into groove of bonnet [9]

Make sure, whether guiding ring is completely in groove

3 Lubricate thread of adjusting screw [18]

4 Screw lock nut [19] on adjusting screw [18]

Check ease of movement of adjusting screw [18]

5 Screw adjusting screw unit approx 15 mm into bonnet [9]

2. Supplies

Molykote D Paste

Lubricate components acc. to LID

3. Tools

None

4. Appliance

None

protected

disclosure cat.:	II	proofread:	Cal	published date:	tbd	effect. date:	02/12
author:	AW	released by:	KUW	replaces:	initial	status:	published
resp. depart.:	PP	date of release:	01/31/12	revision No.:	0		
doc. type:	LGS	change rep. No.:		retention period:	10y.		

9.11 Assembly of the spindle unit

1. Steps – Descriptions

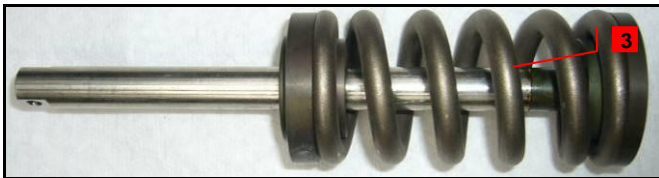

- 1** Cover thread of spindle [12] with screw locking liquid Delo ML 5449
- 2** Screw spindle [12] and (lower) spring plate [17] together
- 3** Put on in that order: spring [54] (optional inner spring [53]), (upper) spring plate [16], needle bearing [69.2] (lubricate bearing) and washer [69.1]

protected

2. Supplies

Screw locking liquid Delo ML 5449
Molykote D Paste
Lubricate components acc. to LID

3. Tools

Drift pin
Torque wrench (Tightening torques acc. to LID)

4. Appliance

Parallel vice with aluminium jaws

disclosure cat.:	II	proofread:	Cal	published date:	tbd	effect. date:	02/12
author:	AW	released by:	KUW	replaces:	initial	status:	published
resp. depart.:	PP	date of release:	01/31/12	revision No.:	0		
doc. type:	LGS	change rep. No.:		retention period:	10y.		

9.12 Assembly of the bonnet and body

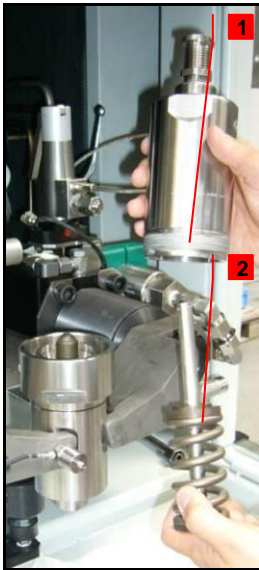

1. Steps – Descriptions

- 1** Lubricate thread of bonnet [9]
- 2** Put spindle [12] unit on (upper) piston [47] and hold on
- 3** Put bonnet [9] over spindle unit and insert spindle into adjusting screw [18]
- 4** Screw on bonnet [9] hand tight
- 5** Tighten bonnet [9]
- 6** Screw lock nut [19] until 1 mm against bonnet

2. Supplies

Molykote D Paste
Lubricate components acc. to LID

3. Tools

Open-end wrench acc. to LID
Torque wrench (Tightening torques acc. to LID)

4. Appliance

Test bench

protected

disclosure cat.:	II	proofread:	Cal	published date:	tbd	effect. date:	02/12
author:	AW	released by:	KUW	replaces:	initial	status:	published
resp. depart.:	PP	date of release:	01/31/12	revision No.:	0		
doc. type:	LGS	change rep. No.:		retention period:	10y.		

9.13 Completion



1. Steps – Descriptions

1 Screw on cap [40] loosely

2 Screw in bug-screen [64]

Option Test Gag:
Screw short screw [TG.5] into cap [40] (finger tight)

protected

2. Supplies

None

3. Tools

Open-end wrench acc. to LID
Torque wrench (Tightening torques acc. to LID)

4. Appliance

Test bench

disclosure cat.:	II	proofread:	Cal	published date:	tbd	effect. date:	02/12
author:	AW	released by:	KUW	replaces:	initial	status:	published
resp. depart.:	PP	date of release:	01/31/12	revision No.:	0		
doc. type:	LGS	change rep. No.:		retention period:	10y.		

9.14 Sealing the valve

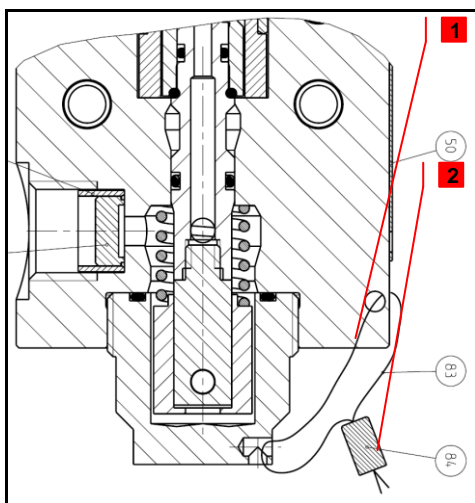
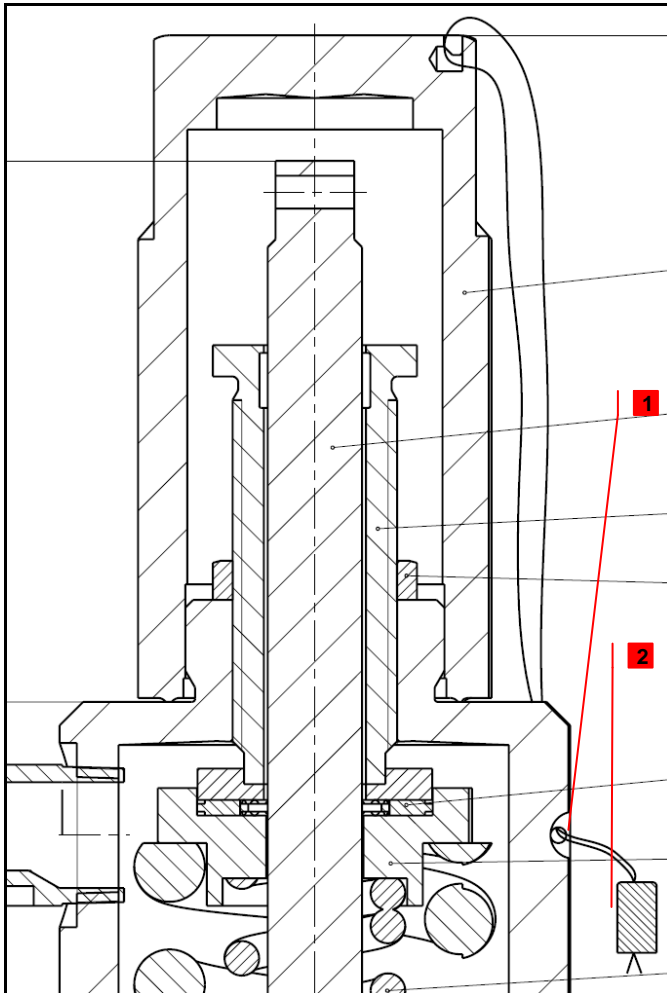

1. Steps – Descriptions

Sealing after assembly and test with main valve!

Seal valve, if a constructive possibility exists. Otherwise you have to weld on sealing noses (cap; bonnet; bonnet)

1 Connect sealing hole/ nose of cap and bonnet with wire tight and in clockwise

2 Close wire ends with seal

Note: In case of required certifications (TÜV etc.) sealing ensued after the certification

protected

2. Supplies

None

3. Tools

Sealing pliers

4. Appliance

None

disclosure cat.:	II	proofread:	Cal	published date:	tbd	effect. date:	02/12
author:	AW	released by:	KUW	replaces:	initial	status:	published
resp. depart.:	PP	date of release:	01/31/12	revision No.:	0		
doc. type:	LGS	change rep. No.:		retention period:	10y.		